

Focus Moduler A/S, Pavillonløsning Oversigt (Plan)

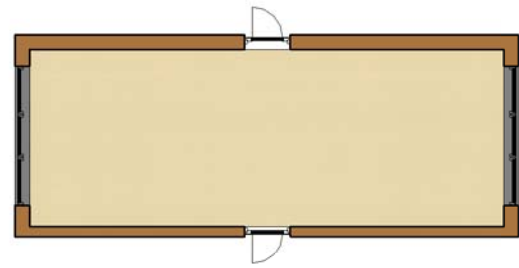

Focus 1
Et lokale

F1
1 : 150

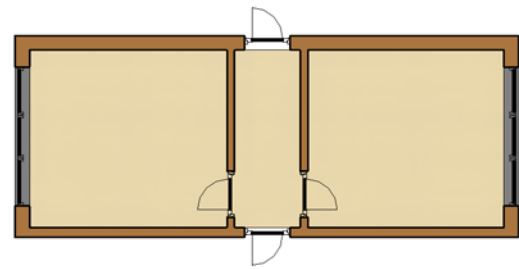

Focus 2
To lokale med
mellemgang

F3
1 : 150

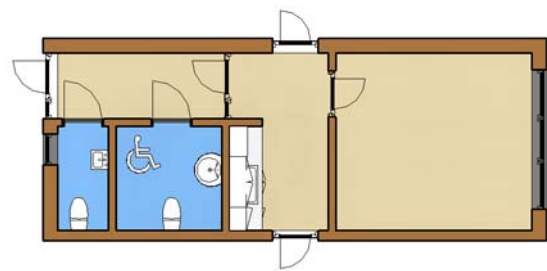

Focus 3
Et lokale, entre,
mellemgang med trinnettekøkken,
garderobe og toiletter

F4
1 : 150

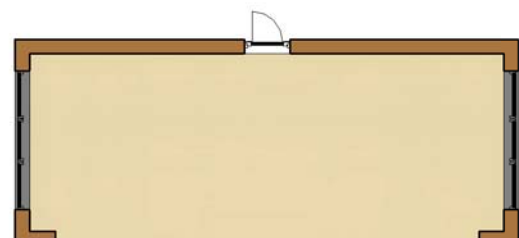

Focus 4
Et lokale uden
venstre langside

Focus 5
Et lokale uden
højre langside

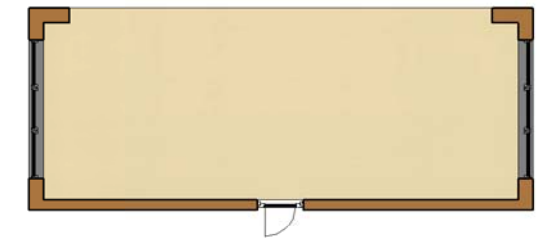

F5
1 : 150

Focus 6
Et lokale uden
langsider



Focus 7
Trappemodul med
mellemgang, entre,
og toiletter - 1.sal

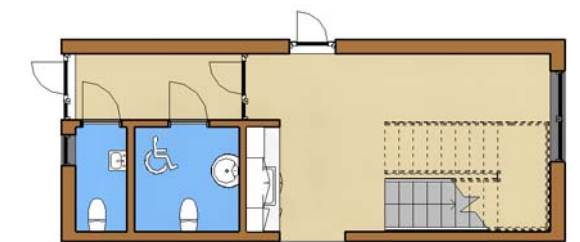

F7
1 : 150

Focus 8
Trappemodul med
mellemgang, entre,
elevador og toilet (stueplan)

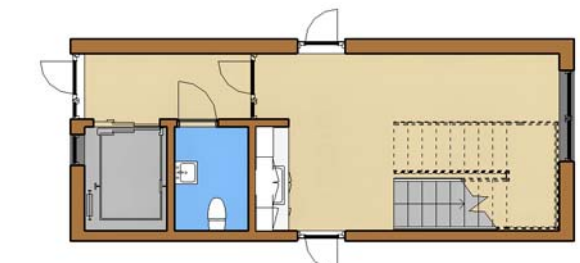

Focus Moduler A/S, Pavillonløsning Oversigt (Indretning)

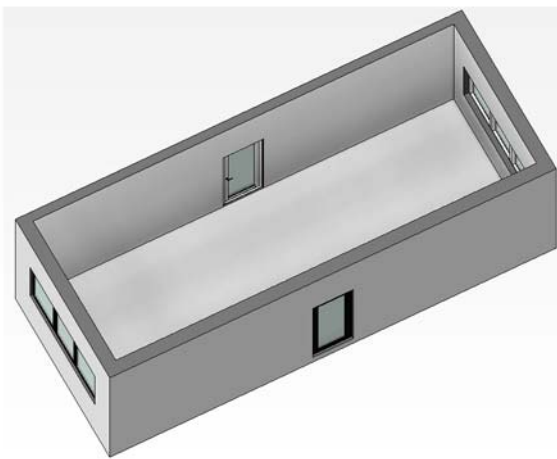

focus 1

Focus 1
Et lokale

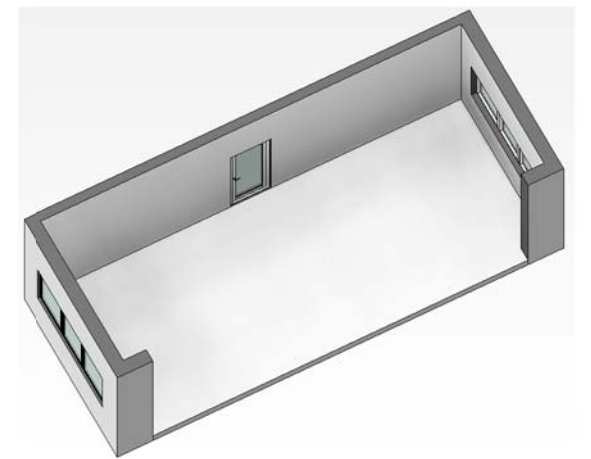

focus 5

Focus 5
Et lokale uden
højre langside

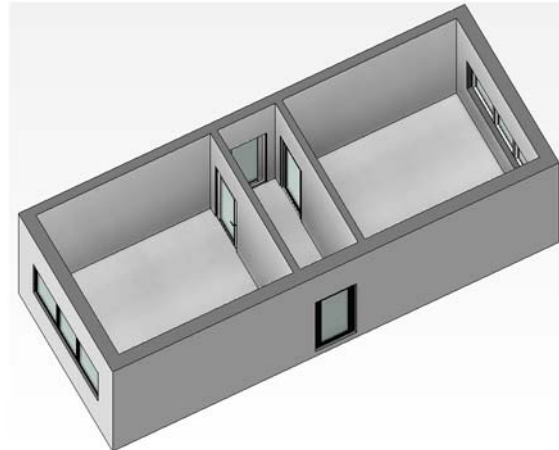

focus 2

Focus 2
To lokale med
mellemgang

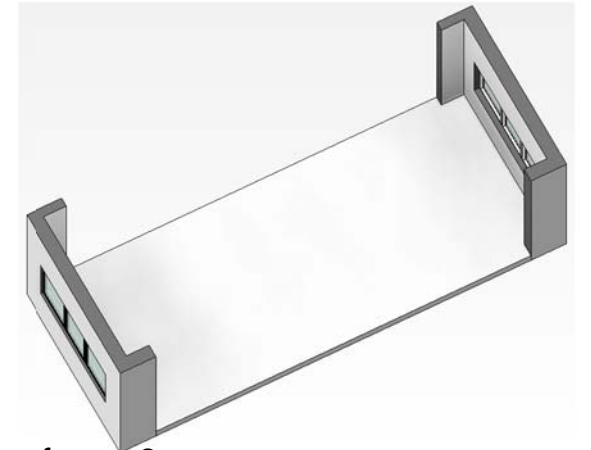

focus 6

Focus 6
Et lokale uden
langsider

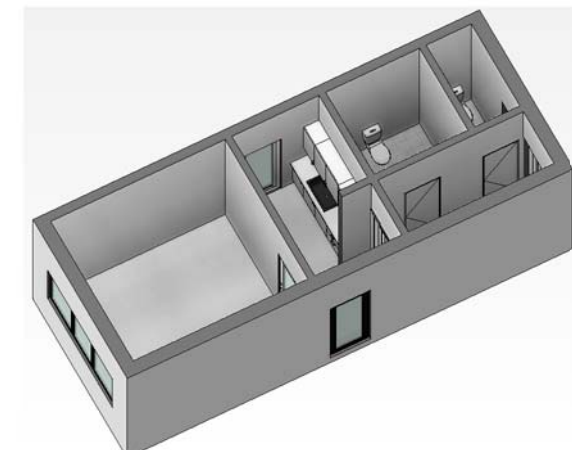

focus 3

Focus 3
Et lokale, entre,
mellemgang med trinnettekøkken,
garderobe og toiletter



focus 7

Focus 7
Trappemodul med
mellemgang, entre,
og toiletter - 1.sal

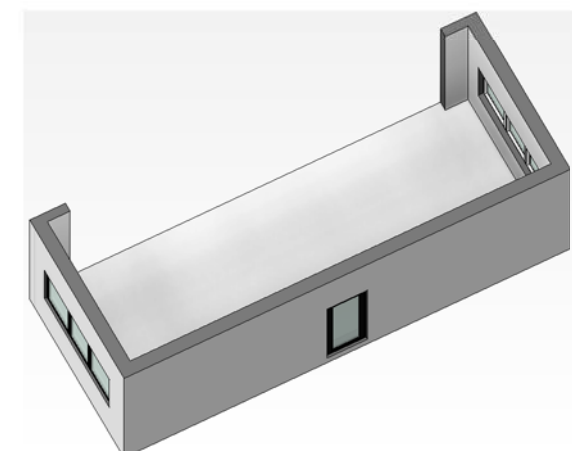

focus 4

Focus 4
Et lokale uden
venstre langside

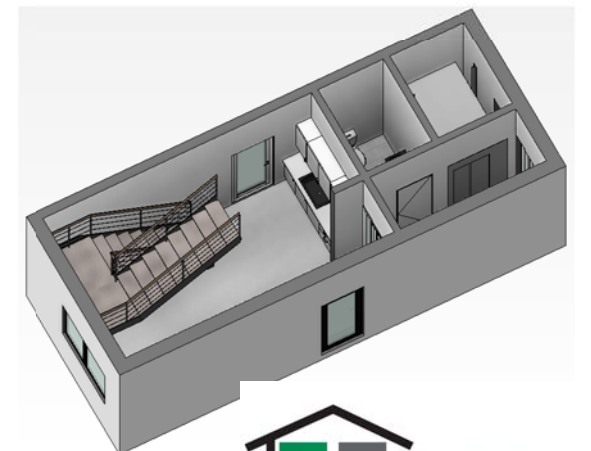

focus 8

Focus 8
Trappemodul med
mellemgang, entre,
elevador og toilet (stueplan)

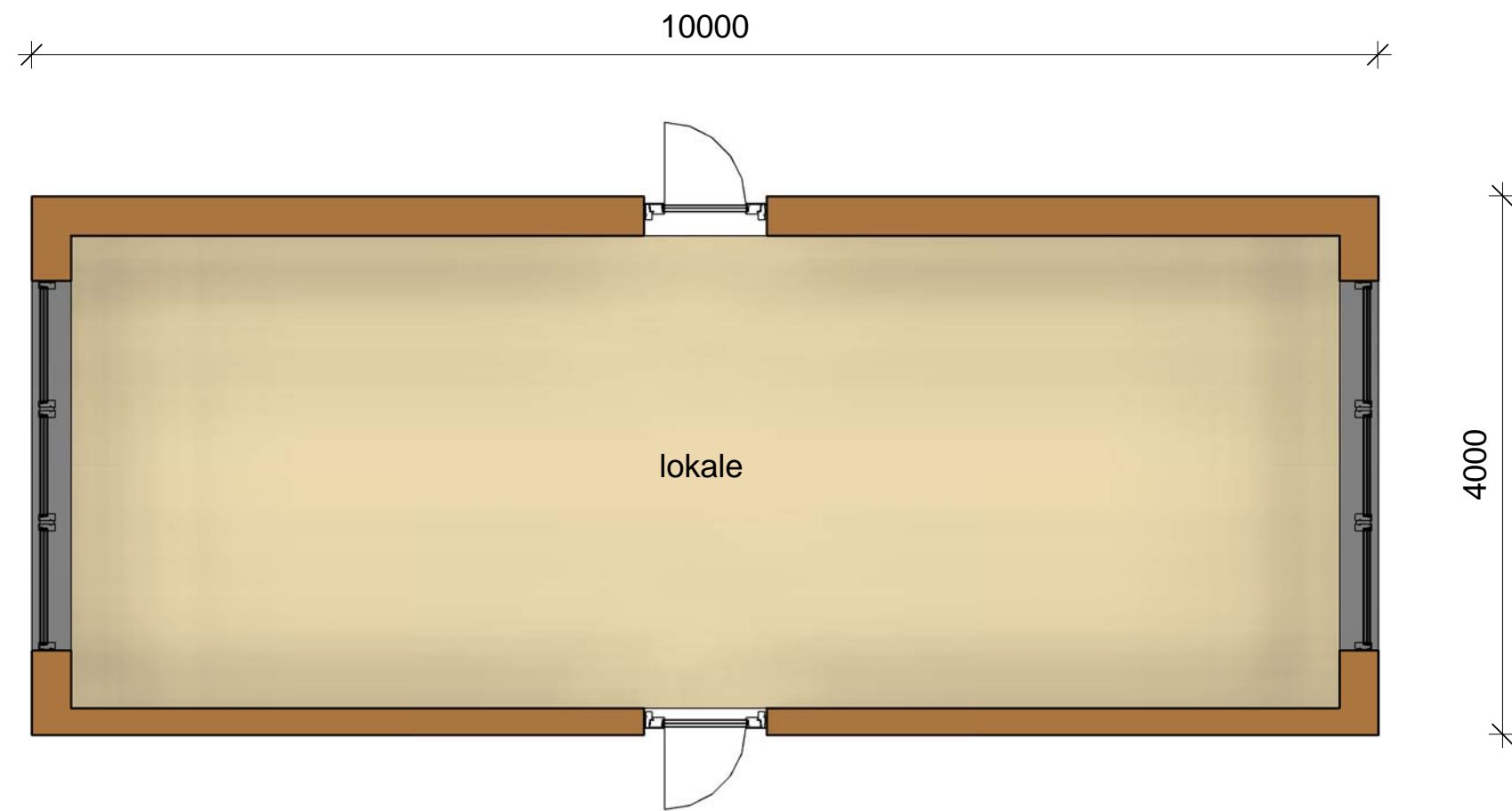

FOCUS 1

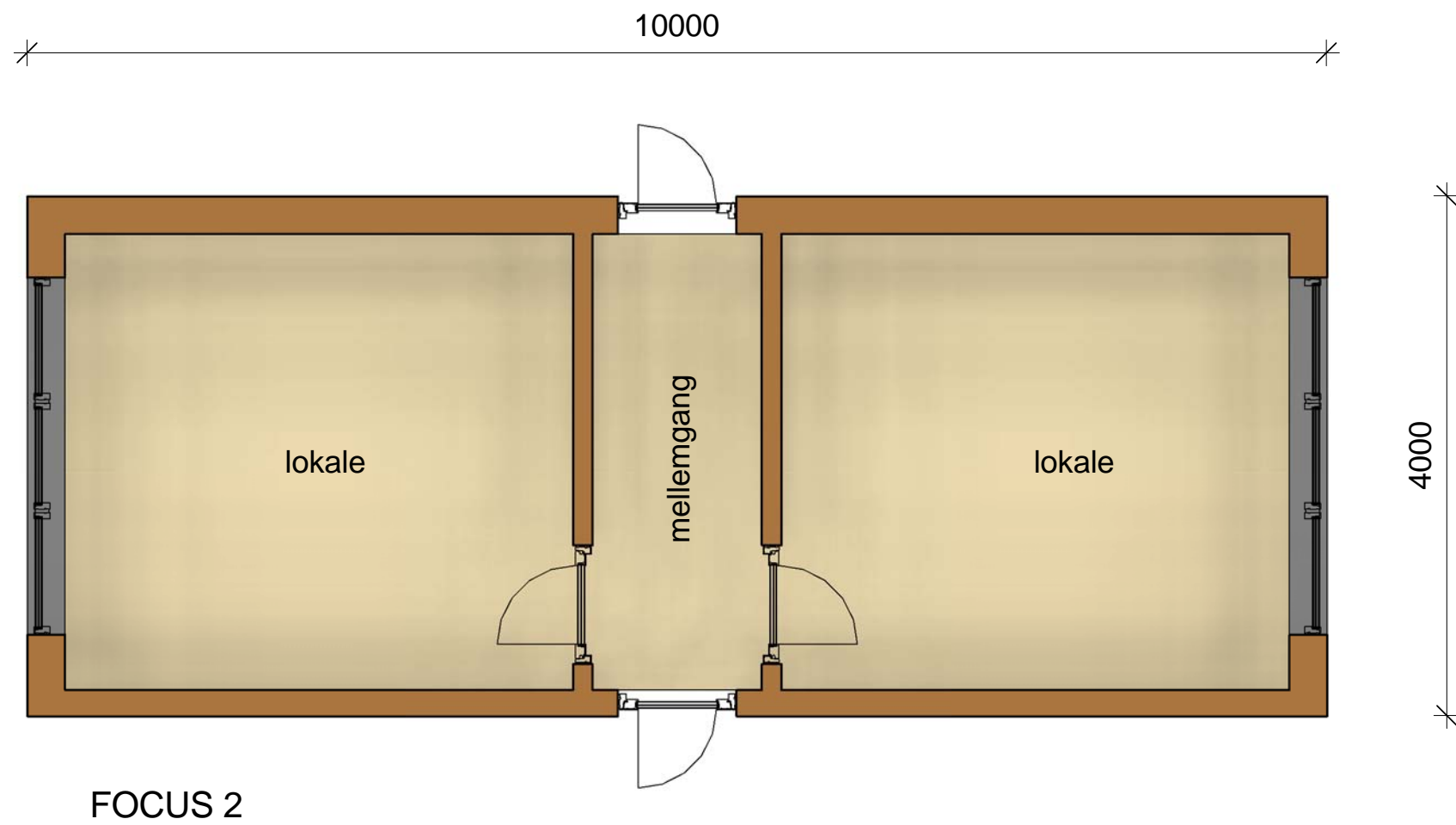

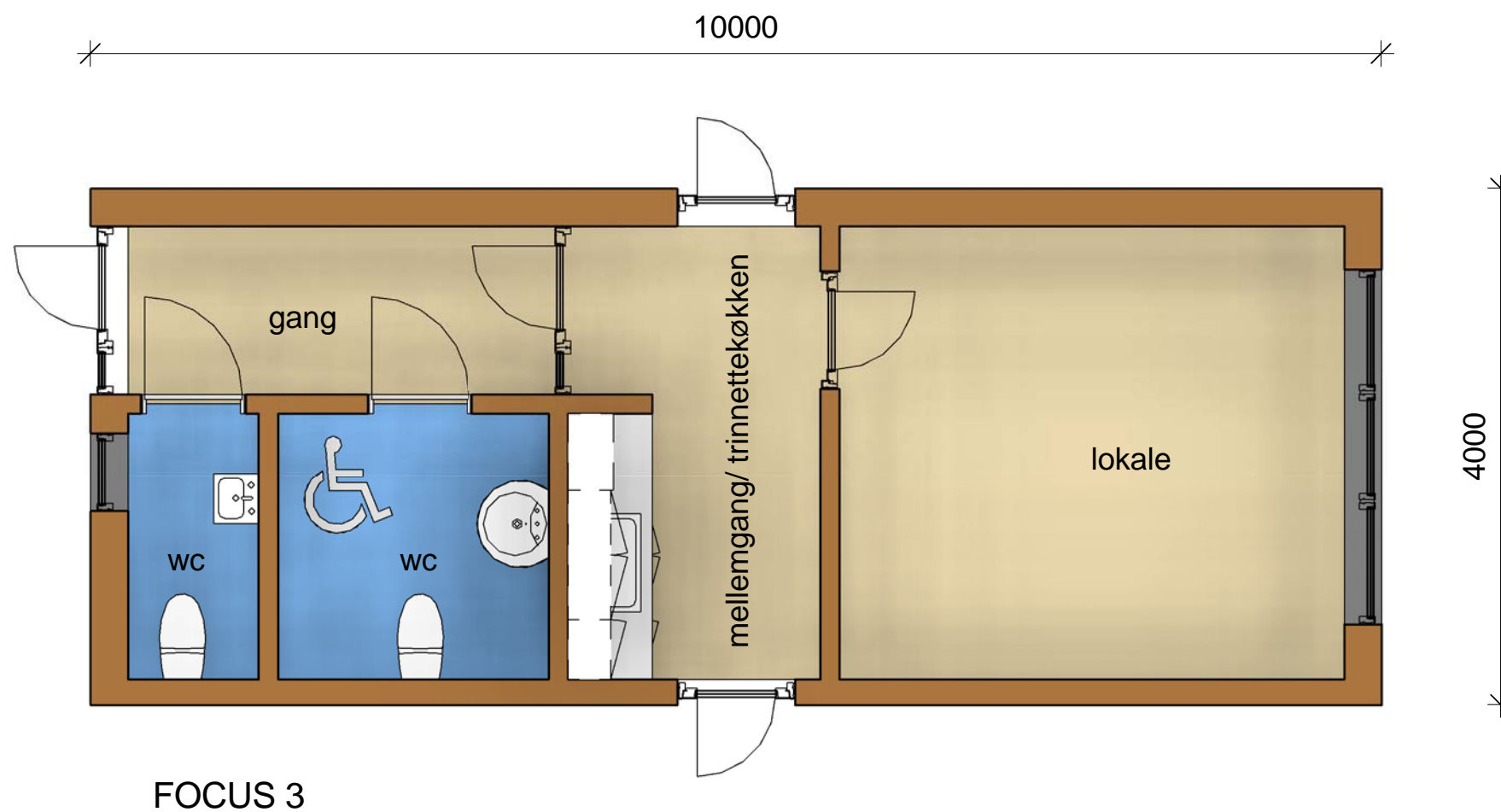

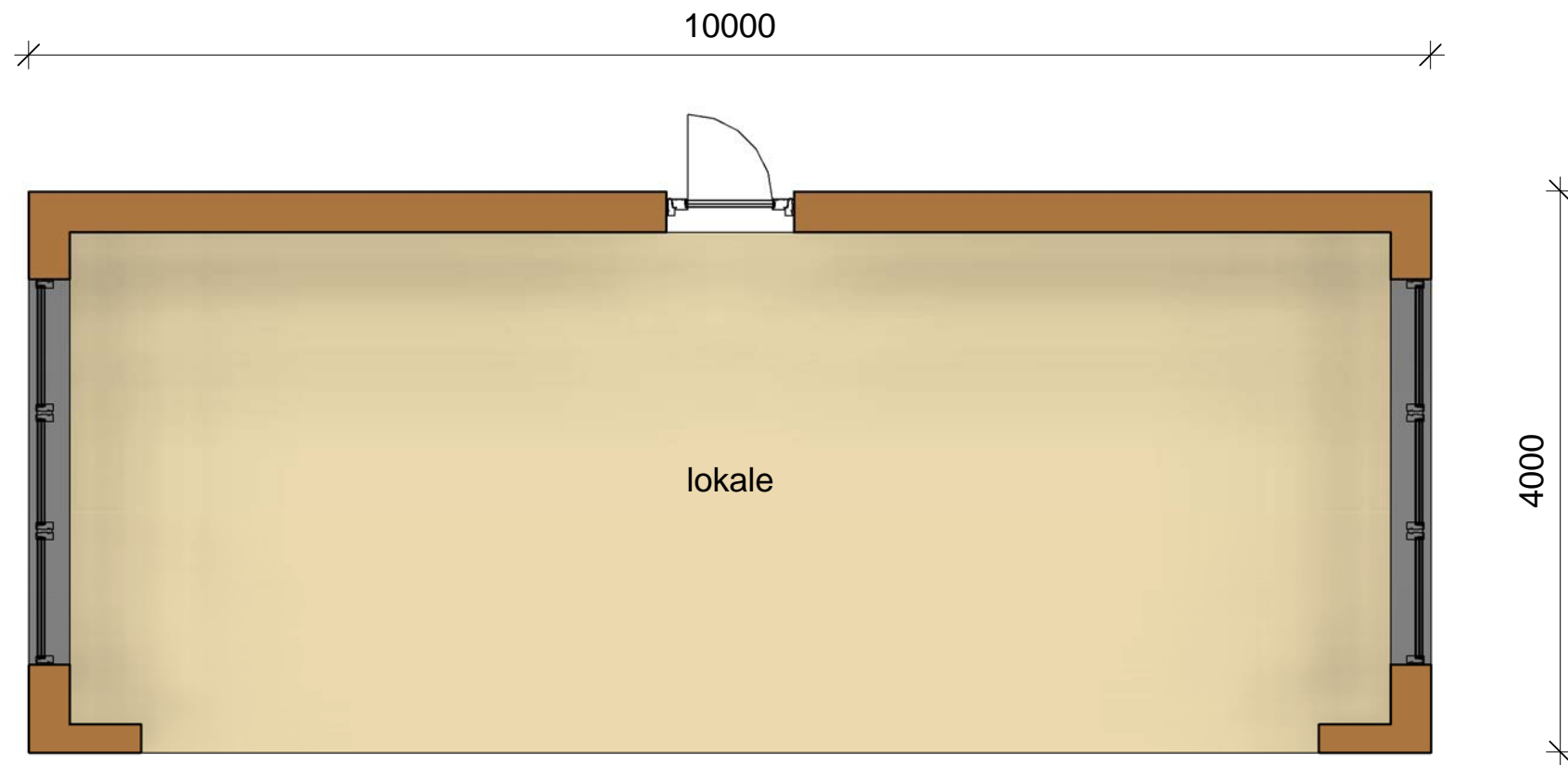

FOCUS 4

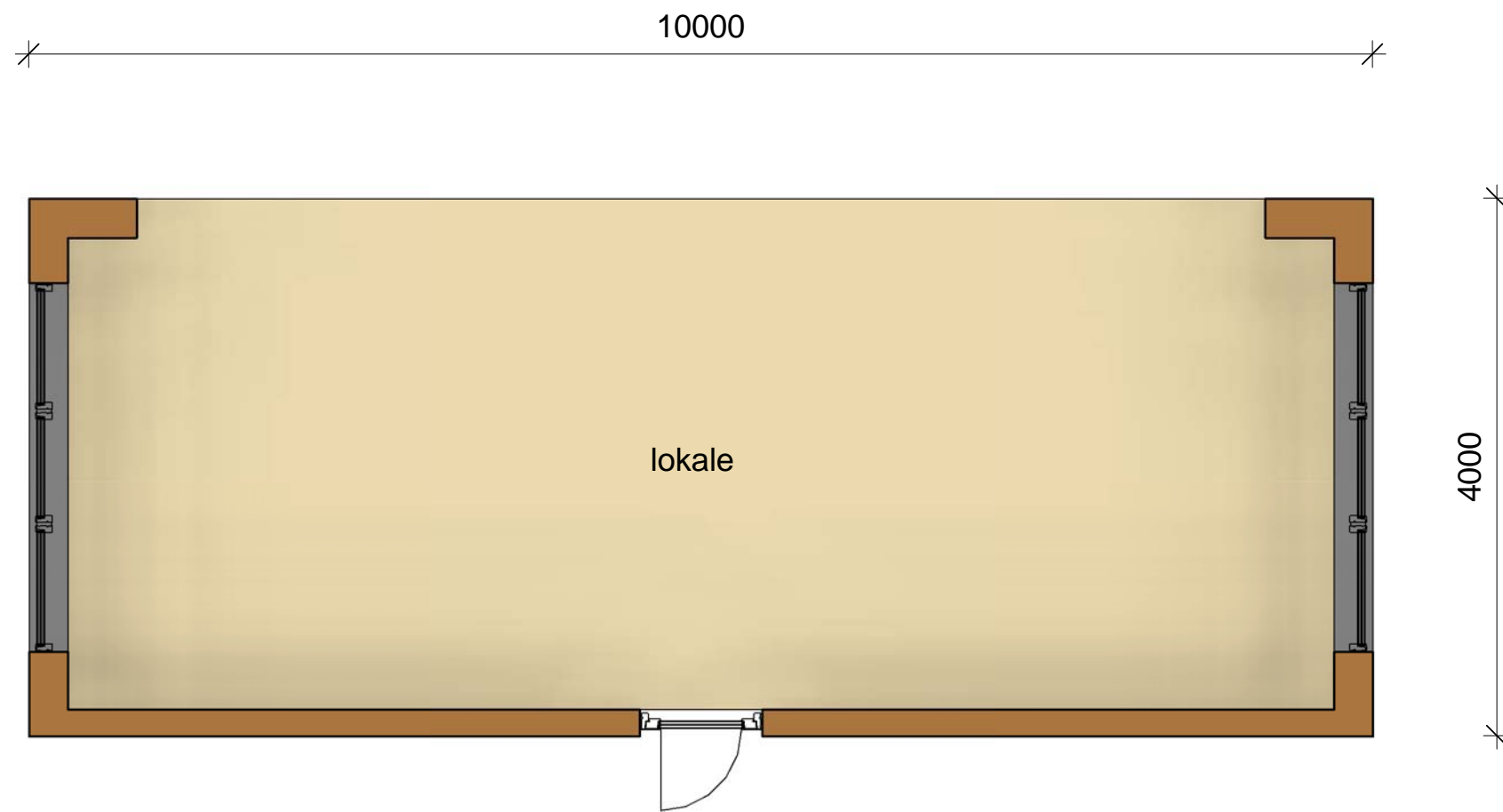

FOCUS 5

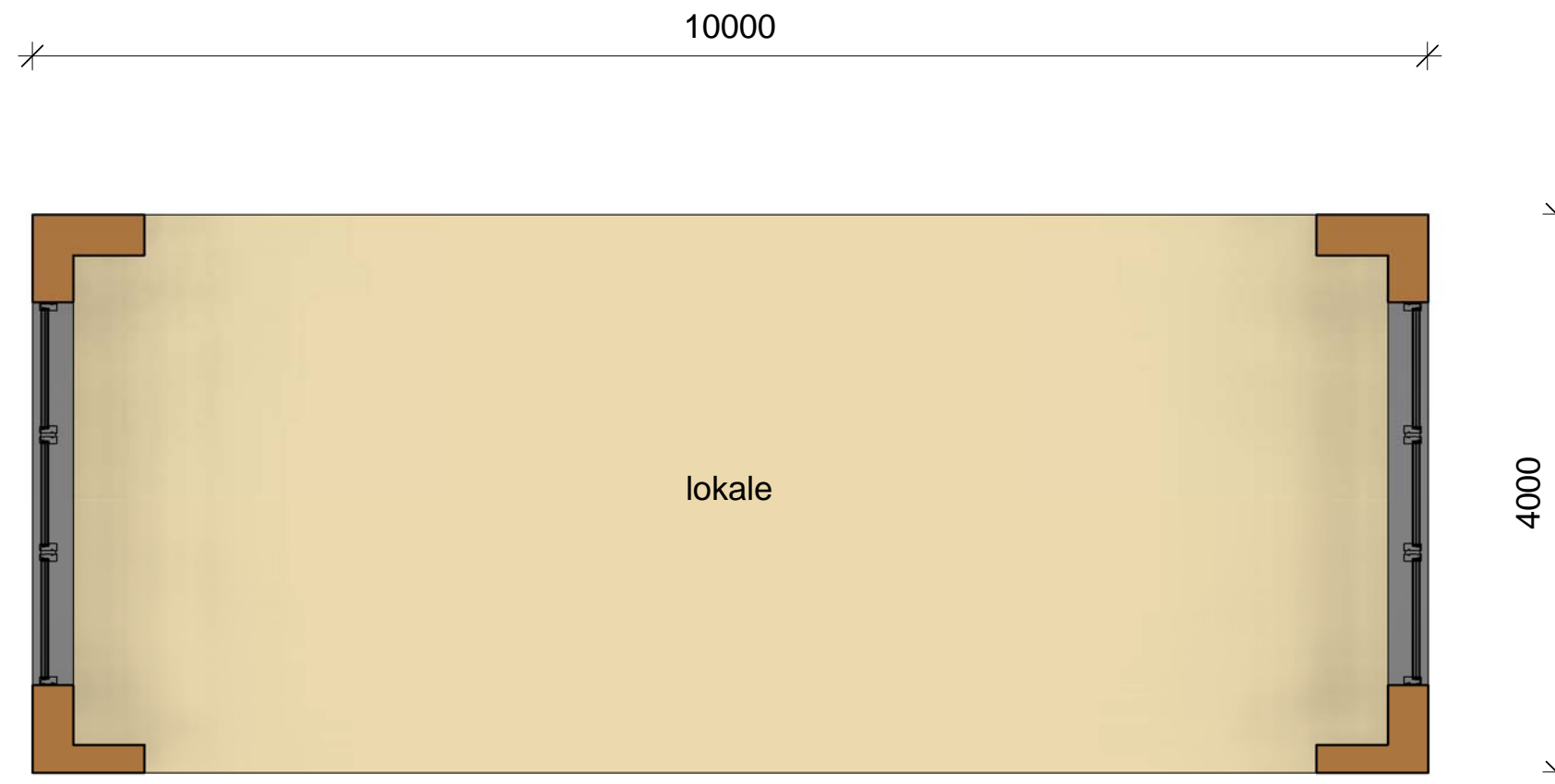

FOKUS 6

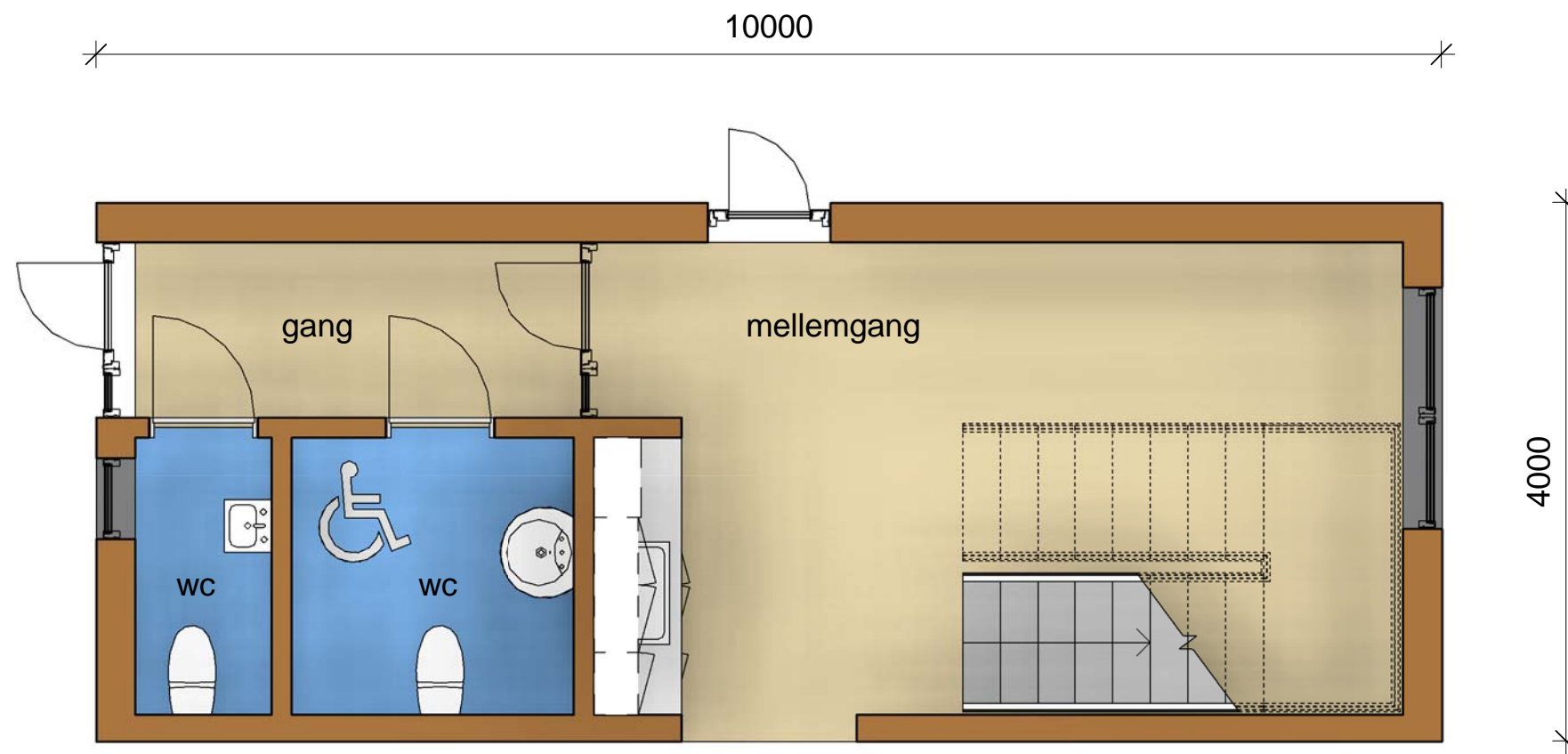

FOCUS 7

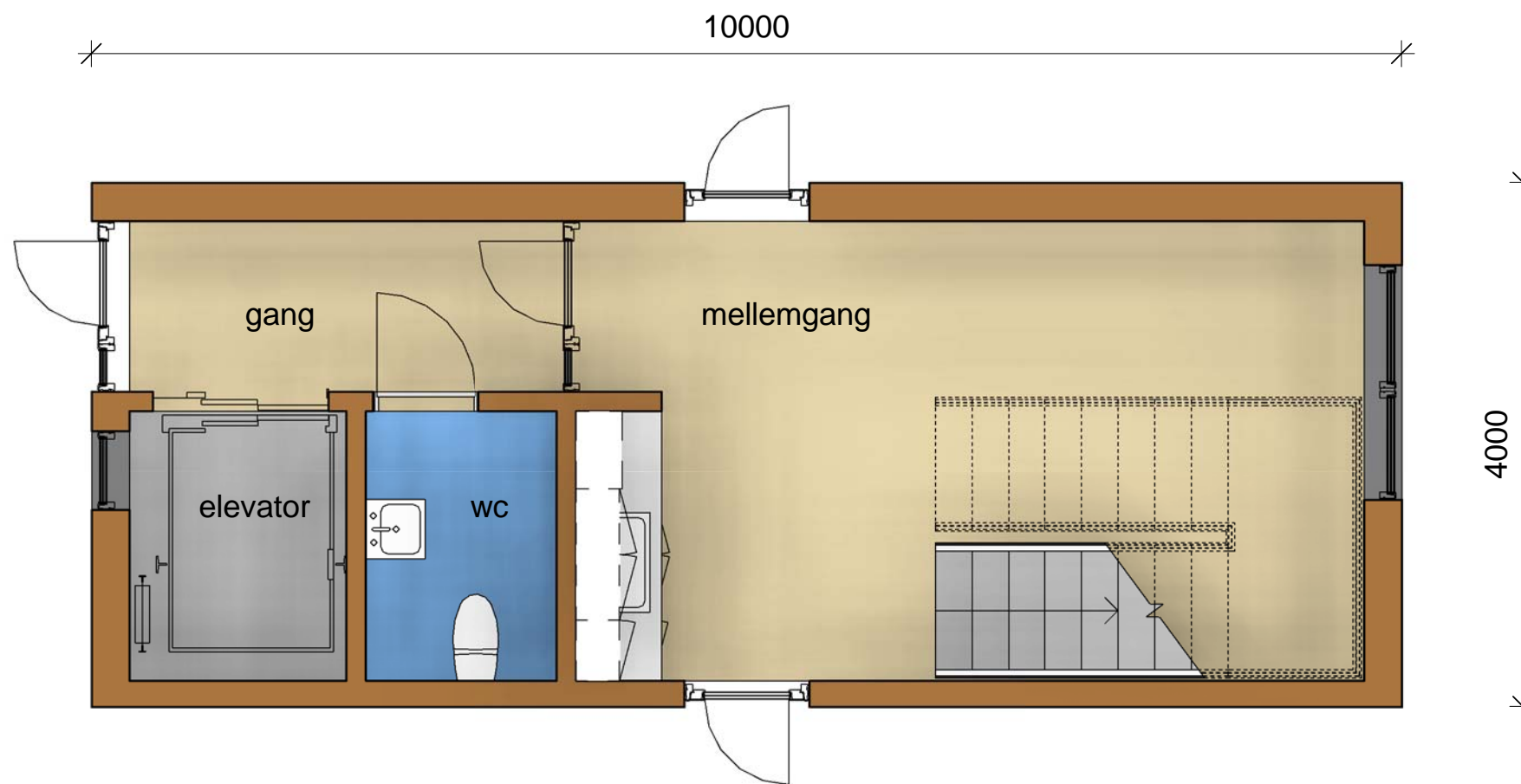

FOCUS 8